

VDF

Belt-driven Cabinet Duct Fan



MOTOR INSULATION CLASS	F CLASS
MOTOR PROTECTION CLASS	IP 55
MOTOR EFFICIENCY CLASS	IE3
MOTOR ENCLOSURE TYPE	TEFC
MOTOR BRAND	GAMAK-VOLT-WAT
BODY MATERIAL	GALVANIZED SHEET METAL
BODY COATING	ELECTRO-STATIC POWDER COATING
IMPELLER MATERIAL	GALVANIZED SHEET METAL
DUTY CYCLE	IEC Duty Cycle-S1
WORKING TEMPERATURE	-20 - +50 °C
STANDARDS	IEC-60335-2-80, ISO 1940-1

Belt-driven cabinet ventilation fans are a type of mechanical fan system used for cooling and ventilating enclosures or cabinets in various industrial applications. These fans are designed to provide efficient airflow and temperature control within equipment cabinets or enclosures that house sensitive electronics, machinery, or other components.

Model	Voltage (V)	Frequency (Hz)	Power (W)	Speed (r.p.m)	Airflow (m ³ /h)	Sound Pressure dB(A)	Weight (kg)
VDF-R 280A	230 / 380	50	1,1	2800	3000	65	44
VDF-R 280B	230 / 380	50	2,2	2800	5500	68	45
VDF-R 315A	230 / 380	50	2,2	2800	7000	70	63
VDF-R 315B	230 / 380	50	3	2800	8000	71	64
VDF-R 355A	230 / 380	50	3	2800	9500	71	84
VDF-R 355B	230 / 380	50	4	2800	10000	73	87
VDF-R 400A	230 / 380	50	4	1400	13000	73	105
VDF-R 400B	230 / 380	50	5,5	1400	15000	75	109
VDF-R 450A	230 / 380	50	5,5	1400	16000	75	134
VDF-R 450B	230 / 380	50	7,5	1400	18500	77	139
VDF-R 500A	230 / 380	50	7,5	1400	20000	77	168
VDF-R 500B	230 / 380	50	11	1400	22500	75	178
VDF-R 560A	230 / 380	50	11	1400	25000	75	282
VDF-R 560B	230 / 380	50	15	1400	30000	74	290
VDF-R 630A	230 / 380	50	15	1400	32500	74	325
VDF-R 630B	230 / 380	50	18,5	1400	37000	76	345

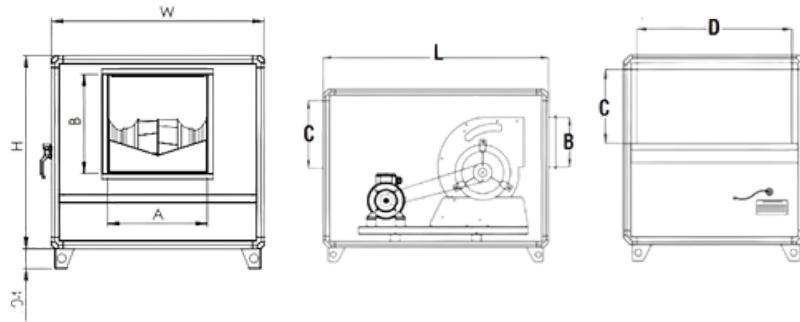

Model	L	W	H	A	B	C	D
VDF-R 280	1050	750	750	361	361	295	670
VDF-R 315	1100	850	850	405	405	345	770
VDF-R 355	1200	900	900	455	455	370	820
VDF-R 400	1300	1100	1100	510	510	470	1020
VDF-R 450	1400	1200	1200	570	570	520	1120
VDF-R 500	1500	1250	1250	640	640	595	1170
VDF-R 560	1500	1350	1350	715	715	670	1270
VDF-R 630	1700	1500	1500	843	843	745	1420

Inlet-Outlet Directions

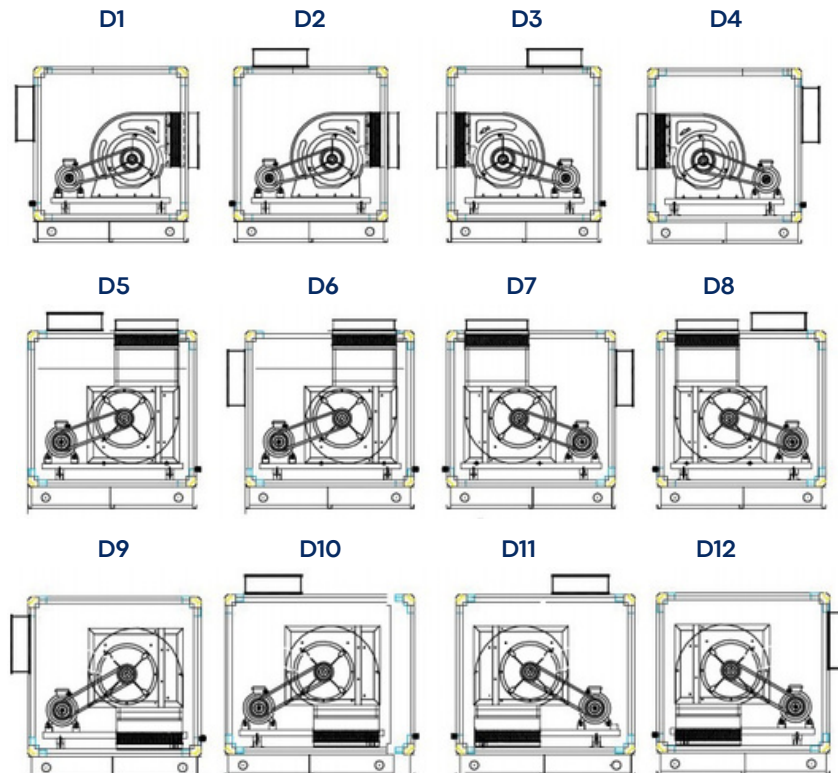

DUCT FANS / Belt Driven Backward Curved Cabinet Duct Fans

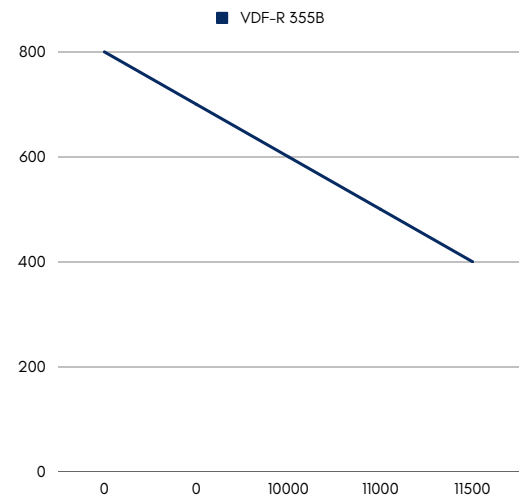
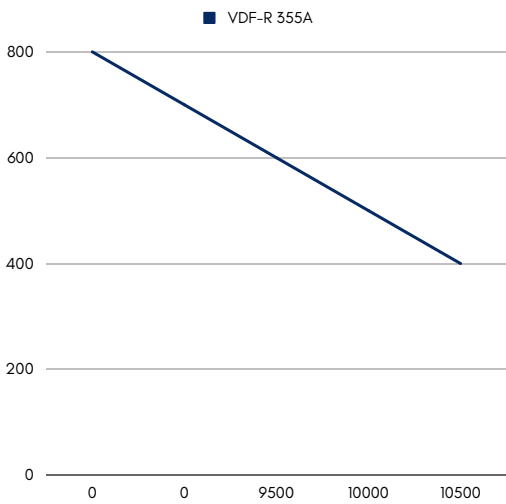
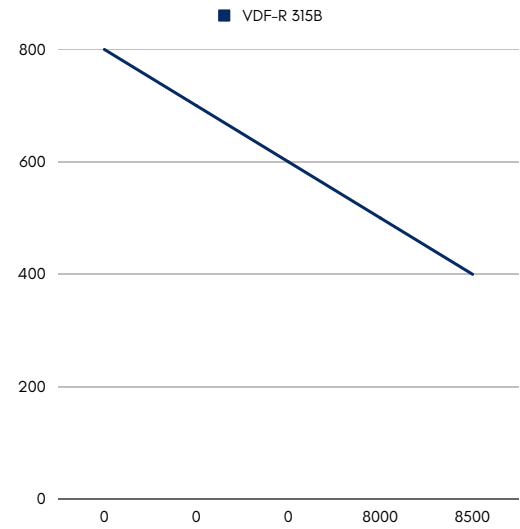
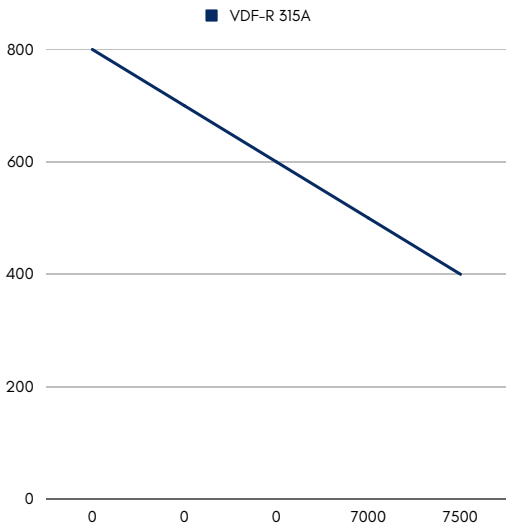
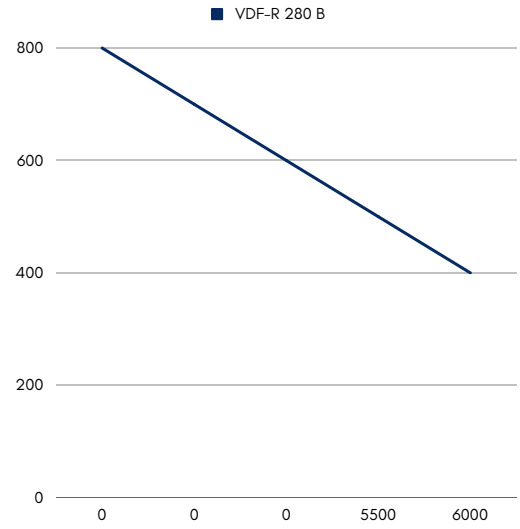
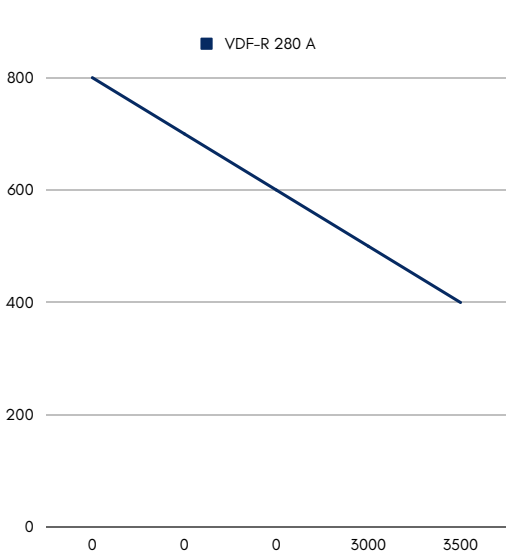

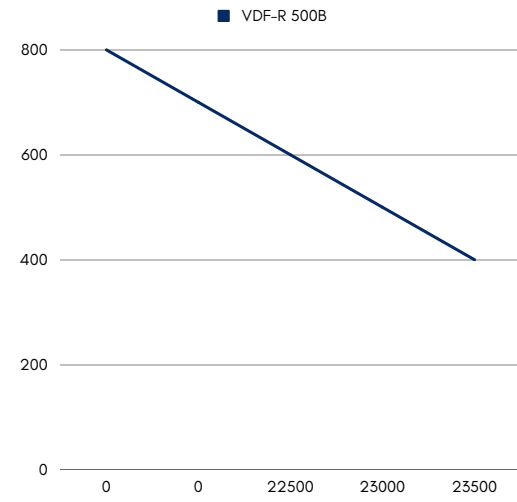
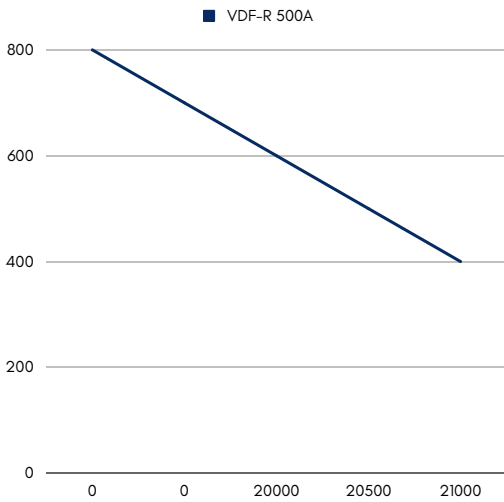
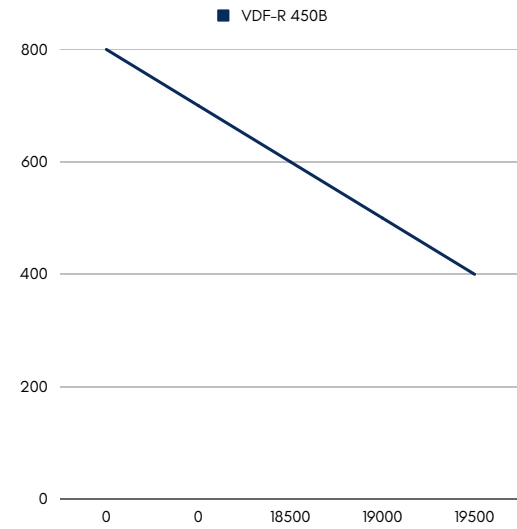
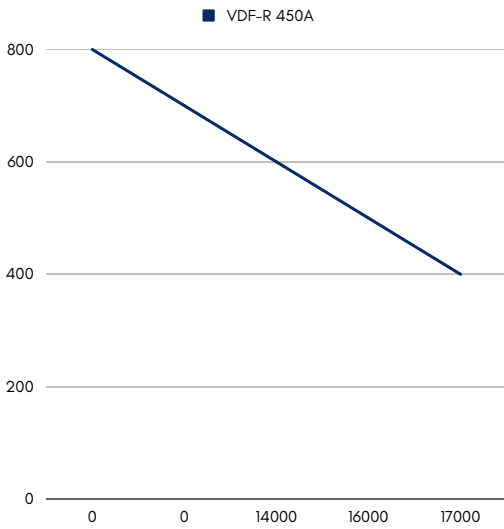
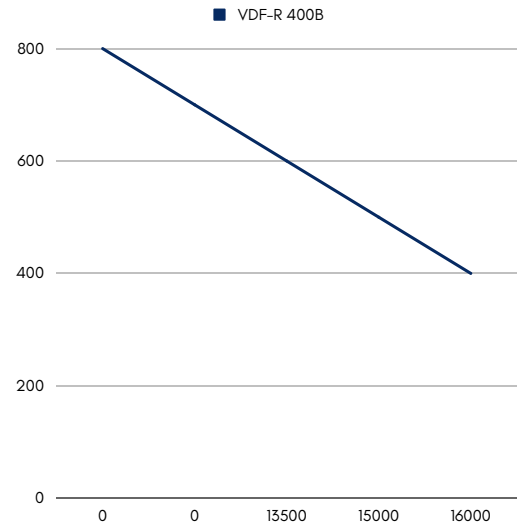
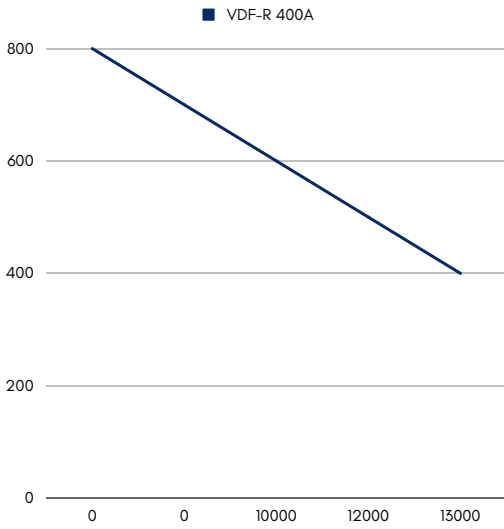

DUCT FANS / Belt Driven Backward Curved Cabinet Duct Fans

